



Form 04583993
Edition 1
November 2004

Air Impact Wrench

2141 and 2141S

Maintenance Information



Save These Instructions

IR Ingersoll-Rand®

Disassembly

General Instructions

1. Do not disassemble the tool any further than necessary to replace or repair damaged parts.
2. Whenever grasping a tool or part in a vise, always use leather-covered vise jaws to protect the surface of the part and help prevent distortion. This is particularly true of threaded members and housings.

NOTICE

Always use leather-covered vise jaws when clamping the handle in a vise. Leather will conform to the shape of the handle and allow the tool to be held securely. To prevent damage to the exhaust diffuser, never clamp only the bottom of the handle.

3. Do not remove any part which is a press fit in or on a subassembly unless the removal of that part is necessary for repairs or replacement.
4. Do not disassemble the tool unless you have a complete set of new gaskets and O-rings for replacement.

Disassembly of the Impact Wrench

1. Clamp the handle of the impact wrench in a vise with leather-covered jaws with the square drive positioned horizontally.

NOTICE

Avoid excessive clamping pressure which can damage the Housing and can cause difficulty when removing the parts.

2. Unscrew and remove the four Hammer Case Screws (12).
3. While lightly tapping on the end of the Anvil (9) with a plastic hammer, lift off the Hammer Case (16) and Hammer Case Gasket (19).

NOTICE

The Front End Plate (2) might come off during the removal of the Hammer Case. Make sure that it does not drop on the floor or strike a hard or metallic surface since it might be damaged.

4. Grasp the Hammer Frame (13) and carefully lift off the entire impact mechanism, making certain not to drop the two Hammer Pins (14).

Disassembly of the Impact Mechanism

1. Set the mechanism, driver end up, on the workbench.

NOTICE

Note the twin hammers within the Hammer Frame. These are identical, but must be placed in the Hammer Frame in a certain relationship. Using a felt-tipped pen, mark the top hammer "T↑" and the bottom hammer "B↑" with the arrows pointing upward. Mark both Hammers on the same end.

2. With the mechanism sitting upright on the workbench, slowly rotate the Anvil in a clockwise direction until it comes up solid.

NOTICE

If you continue to rotate the Anvil, it will cam the Hammers out of engagement. Don't do this; merely rotate the Anvil until it comes up solid.

3. Hold the Hammer Frame firmly and without disturbing the hammers, gently lift the Anvil while simultaneously rotating it clockwise about 1/8 of a turn, from the Hammer Frame.
4. With the Anvil removed, lift out the two Hammer Pins.

NOTICE

The twin hammers are now free to slide from the Hammer Frame. Be careful do not to drop them.

Disassembly of the Motor

NOTICE

When pulling, disassembling or assembling the motor, we recommend replacement of the Motor Gasket (8).

1. Remove the Motor Assembly from the Housing (20) by pushing on Power Management Dial (42) from the back of the Housing. See Dwg. TPD1322.

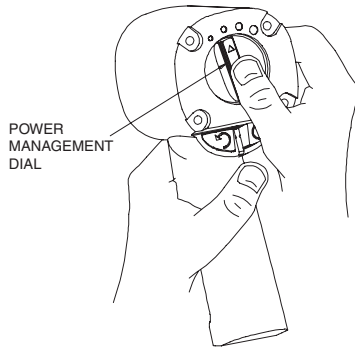

(Dwg. TPD1322)

NOTICE

If the Motor Assembly cannot be removed from the Housing by pushing, tap the Power Management Dial lightly until the Motor Assembly is free.

2. Remove the Power Management Dial from the rear of the Cylinder (1). Remove the Power Management Dial Seal (43) if it needs to be replaced.
3. Remove the Front End Plate (2) from the Cylinder by tapping the splined end of the Rotor (6) with a plastic hammer. If the Front End Plate does not come loose, secure a center punch in a vise with the point angled downward and outward from the vise. Grasp the Cylinder and Front End Plate in one hand and position the hole in the end of the Rotor against the punch.

NOTICE

Be careful not to drop the Cylinder since it can be damaged by hitting a hard surface.

Using the other hand, tap the punch with a hammer while pressing the Rotor against the punch. After a few taps, the Front End Plate will slide off of the Cylinder.

NOTICE

To prevent damage to the Cylinder, do not tap or strike Cylinder on a hard or metallic surface when removing the Rotor Bearings (3) and (4).

To remove the Front Rotor Bearing, hold the Front End Plate with Front Rotor Bearing down and tap the Front End Plate on a flat, nonmetallic surface such as a work bench. This will loosen the Front Rotor Bearing so that it will drop out of the Front End Plate. See Dwg. TPD1323.

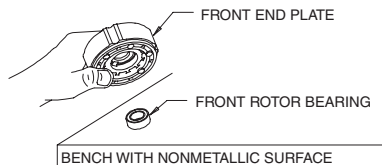

(Dwg. TPD1323)

- Remove the Rear Rotor Bearing Retainer (7) from the rear of the Rotor (6). The Rotor can now be removed from the Cylinder. Remove the Vanes (5) from the Rotor if they need to be replaced.

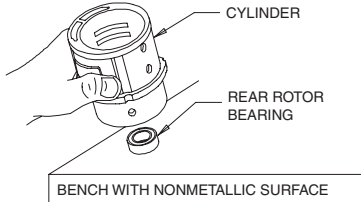

(Dwg. TPD1324)

- To remove the Rear Rotor Bearing, hold the Cylinder with the Rear Rotor Bearing down and tap the Cylinder on a flat, nonmetallic surface such as a work bench. This will loosen the Rear Rotor Bearing so that it will drop out of the Cylinder. See Dwg. TPD1324.
- Working from the rear of the Housing, push out the Motor Gasket (8).

NOTICE

When removing the Motor Gasket, do not use a screwdriver or any other sharp object which could damage the Gasket and/or Housing.

Disassembly of the Throttle Mechanism

NOTICE

For ease of disassembly, we recommend using the Inlet Clip Removal Tool (44). See Dwg. TPD1812.

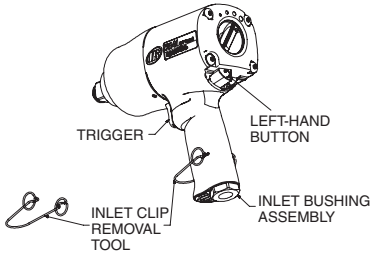

(Dwg. TPD1812)

- Secure the Inlet Bushing in a vise. Press in both tabs of the Inlet Retainer Clip (26) and pull upward on the Housing (20). This will allow the Inlet Bushing to come free from the Handle of the Housing. See Dwg. TPD1326.
- Pull the Trigger (34) from the front of the Housing and remove the Trigger O-ring (35).

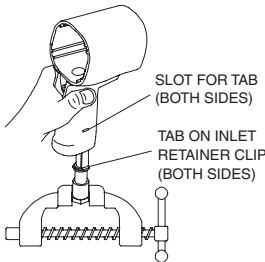

(Dwg. TPD1326)

- With the Inlet Bushing still in the vise, remove the Tilt Valve Seat Retainer (33) and Tilt Valve Seat Support (32). Use a hooked tool with no sharp edges to remove the Tilt Valve Seat (31) from the Inlet Bushing. See Dwg. TPD1327.

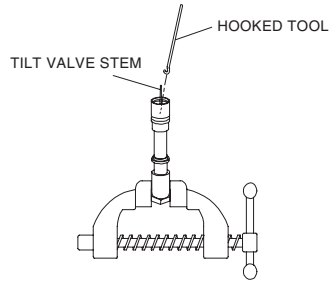

(Dwg. TPD1327)

- Remove the Tilt Valve (30) and Tilt Valve Spring (29) if damaged.
- Remove the Inlet Bushing Seal (28) and Inlet Retainer Clip (26) if damaged.

NOTICE

Do not remove the Inlet Bushing Screen (25) from the Inlet Bushing unless it is damaged. Clean the Inlet Bushing Screen by using a suitable cleaning solution in a well ventilated area.

Disassembly of the Reverse Valve Mechanism

NOTICE

The Reverse Valve Assembly cannot be removed without first removing the Forward and Reverse Buttons (40) and (41). Therefore, it is important that the procedure below be followed exactly.

- Insert the screwdriver between the partition and the Button which is fully extended. **Gently** pry against the Button to disengage the detent so that the Button can be removed. After the Button is removed, reach inside the Housing and rotate the Reverse Valve to extend the remaining Button. Repeat the above procedure for the remaining Button. See Dwg. TPD1328.

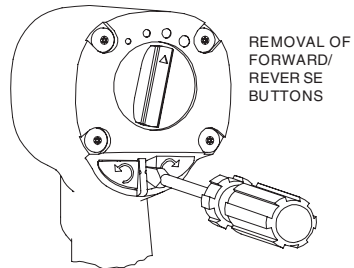

(Dwg. TPD1328)

- Insert thumb into the front of the Housing and push **down** on the Reverse Valve so that it can be removed through the bottom of the handle. See Dwg. TPD1329.

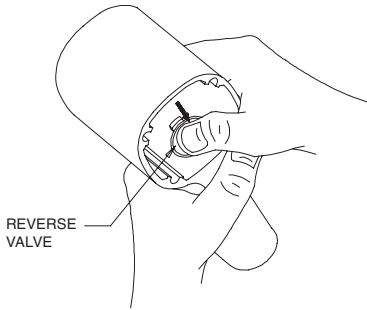

(Dwg. TPD1329)

NOTICE

Do not try to remove the Reverse Valve by pushing upward. It can only be removed by pushing it downward and out of the bottom of the handle. If the Reverse Valve does not come free, tap the bottom of the handle lightly with a rubber hammer until it drops out.

- Remove the Top Reverse Valve O-ring (37) and the Bottom Reverse Valve O-ring (38) from the Reverse Valve.

Assembly

General Instructions

- Whenever grasping a tool or part in a vise, always use leather-covered vise jaws to protect the surface of the part and help prevent distortion. This is particularly true of threaded members and housings.

NOTICE

Always use leather-covered vise jaws when clamping the handle in a vise. Leather will conform to the shape of the handle and allow the tool to be held securely. To prevent damage to the exhaust diffuser, never clamp only the bottom of the handle.

- Always clean every part and wipe every part with a thin film of oil before installation.

NOTICE

Do not remove grease from the impact mechanism or Hammer Case (16). If the impact mechanism has not been disassembled, inject Ingersoll-Rand No. 115-1LB Grease through the Hammer Case Grease Fitting (18).

When disassembling and assembling the impact mechanism, remove all grease from the impact mechanism and Hammer Case and lubricate the impact mechanism and Hammer Case Bushing (17) with Ingersoll-Rand No. 105-1LB Grease or Ingersoll-Rand No. 105-8LB Grease.

- Apply a film of O-ring lubricant to all O-rings before final assembly.

Assembly of the Reverse Valve Mechanism

- Install the Bottom Reverse Valve O-ring (38) (color-coded blue) and the Top Reverse Valve O-ring (37) on the Reverse Valve (36).
- Insert the Reverse Valve in the bottom of the handle making sure that two ears on the Reverse Valve are facing downward. See Dwg. TPD1330.

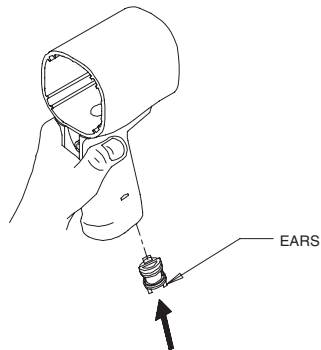

(Dwg. TPD1330)

Use a wooden dowel to push the Reverse Valve up through the handle until the top of the Reverse Valve is flush with or slightly above the bottom of the motor bore in the Housing (20). See Dwg. TPD1331.

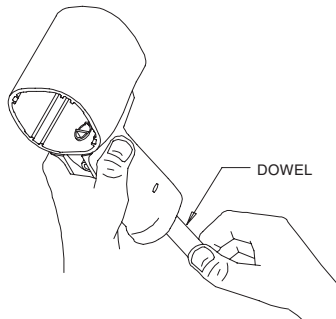

(Dwg. TPD1331)

NOTICE

If the Reverse Valve is pushed up too far and becomes wedged, it will have to be pushed back down through the handle and re-inserted from the bottom of the handle. The Reverse Valve cannot be removed by pushing it up through the handle and into the motor bore. If the Reverse Valve must be removed and re-installed, make sure that the Top and Bottom Reverse Valve O-rings have not been rolled off and are in their proper positions on the Reverse Valve.

- When the Reverse Valve has been installed, rotate the Reverse Valve so that the tab on the Reverse Valve is at the rear of the Housing.
See Dwg. TPD1332.

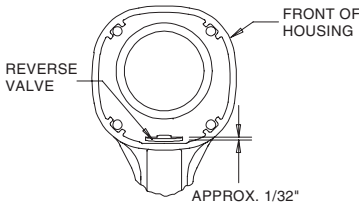

(Dwg. TPD1332)

NOTICE

If the orientation of the Reverse Valve is not correct (tab facing the rear of the Housing), the Trigger (34) and the Forward and Reverse Buttons (40) and (41) cannot be installed.

- Install the Trigger O-ring (35) on the Trigger. Insert the Trigger Assembly in the front of the Housing.
- Rotate the Reverse Valve in either direction until an ear comes up against the Trigger.
- Look through the Housing from the rear. If the tab on the Reverse Valve has been rotated to the left, install the right Button in the Housing. When one Button has been installed, push the Button in. This will rotate the Reverse Valve so that the other Button can be installed.
See Dwg. TPD1333.

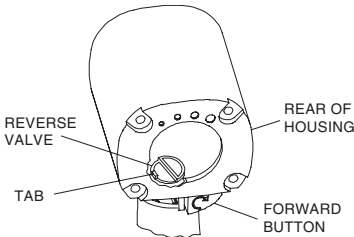

(Dwg. TPD1333)

If the tab on the reverse Valve has been rotated to the right, install the left Button. See Dwg. TPD1334.

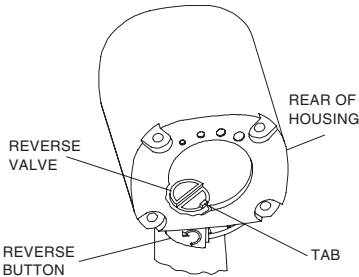

(Dwg. TPD1334)

NOTICE

If the Forward/Reverse Buttons will not install easily, move the Reverse Valve slightly higher in the handle to provide better alignment with the Buttons.

- After the Forward/Reverse Buttons have been installed, remove the Trigger before proceeding with installation of the throttle mechanism.

Assembly of Throttle Mechanism

- Using an Inlet Bushing Screen Installation Tool, install the Inlet Bushing Screen (25), screened end first, in the bottom (hex end) of the Inlet Bushing (24). Insert the rounded end of the tool in the cone formed by the screen and tap the end of the tool to secure the rim of the screen in the Bushing. See Dwg. TPD1473.

Inlet Bushing Screen Installation Tool

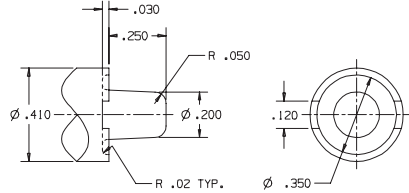

(Dwg. TPD1473)

- Install the Inlet Retainer Clip (26), Inlet Bushing Seal (28), Tilt Valve Spring (29), Tilt Valve (30) Tilt Valve Seat (31) and Tilt Valve Seat Support (32).



WARNING

The Tilt Valve Seat Retainer (33) must be properly installed in the groove in the Inlet Bushing (24). To check for correct installation of the Retainer, insert a pin into one of the holes in the Retainer and rotate the Retainer. A correctly installed Retainer will rotate freely but with some resistance in the groove of the Inlet Bushing. An incorrectly installed Retainer will pop out of the Inlet Bushing when the Retainer is rotated.



WARNING

Do not use compressed air to check installation of the Tilt Valve Seat Retainer or Inlet Bushing Screen unless the entire Inlet Bushing Assembly is installed in the tool with the Hammer Case installed and properly secured to the Motor Housing. Failure to do so could result in injury.

- Install the Tilt Valve Seat Retainer.

NOTICE

When re-installing the Inlet Bushing Assembly, pull the Trigger (34) outward and make sure that the Reverse Button (41) is depressed before snapping the Inlet Bushing Assembly back into the Housing.

- Install the Inlet Bushing Assembly by pushing it into the hole in the Housing until you see and hear the tabs on Inlet Retainer Clip snap into place through the slots in Housing handle.

NOTICE

The Reverse Button (left) (41) must be pushed in before the Trigger can be installed. Otherwise, the Trigger will be damaged during installation.

- Install the Trigger by pushing it into the handle until a click is heard indicating that it is properly engaged.

Assembly of the Motor

NOTICE

When disassembling, assembling or pulling the Motor, we recommend replacement of the Motor Gasket (8).

- Install the Motor Gasket in the Housing making sure that the grooves in the tab of the Motor Gasket fit around ridge in the Housing.
See Dwg. TPD1336.

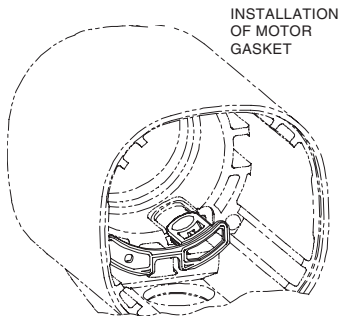

(Dwg. TPD1336)

2. Install the Rear Rotor Bearing (4) into the rear of the Cylinder (1).
3. Install the Rotor in the Cylinder and secure with the Rear Rotor Bearing Retainer (7).
4. Install Vanes (5) in the slots in the Rotor (6).
5. Install the Front Rotor Bearing (3) into the Front End Plate (2). Install the Front End Plate on the Cylinder by pressing on the inner face of the front Rotor Bearing until the Bearing is seated on the Rotor Shaft.
6. Install the Power Management Dial Seal (43) on the Power Management Dial (42), and install the Dial in the end of the Cylinder.
7. Clean the Silencer (45) using a suitable cleaning solution in a well-ventilated area. Position the Silencer over the top of the Cylinder and insert the Motor Assembly into the Housing (20), Power Management Dial end first.

Assembly of the Impact Mechanism

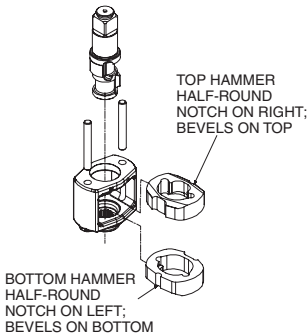

(Dwg. TPA1813)

1. Coat the Hammers (15) with a light film of No. **Ingersoll-Rand** 105-1LB Grease or **Ingersoll-Rand** No. 105-8LB Grease.
 2. Heavily coat the jaws of the Anvil (9) with **Ingersoll-Rand** No. 105-1LB Grease or **Ingersoll-Rand** No. 105-8LB Grease.
 3. Replace the Hammers in the Hammer Frame (13) exactly as they were when you marked them prior to disassembly.
 4. Replace the Hammer Pins (14).
 5. Examine the base of the Anvil (9) and note its contour. While looking down through the Hammer Frame, swing the top Hammer to its full extreme one way or another until you can match the contour of the Anvil. Enter the Anvil into the Hammer Frame and through the first Hammer. Swing the bottom Hammer in the opposite direction from the top Hammer and maneuver the Anvil slightly until it drops into the bottom Hammer.
- See Dwg. TPD1813.

NOTICE

Be sure to position the Top Hammer with the half-round notch on the right and the bevels on the top, and the Bottom Hammer with the half-round notch on the left and the bevels on the bottom, as shown in Dwg. TPA1813.

Assembly of the Air Wrench

1. Position the Motor Housing (20) in leather-covered vise jaws with the splined shaft of the Rotor in a horizontal position.
2. Place the assembled impact mechanism down onto the splined hub of the Rotor.
3. Position the Hammer Case Gasket (19) against the face of the Motor Housing.

NOTICE

Be sure that the small tab on outside surface of the Gasket is located in line with the center of the Trigger.

See Dwg. TPA1811.

4. Apply a thin film of **Ingersoll-Rand** No. 105-1LB Grease or **Ingersoll-Rand** 105-8LB Grease on inside surface of the Hammer Case Bushing (17), and place the Hammer Case (16) down over the Anvil and against the Motor Housing.

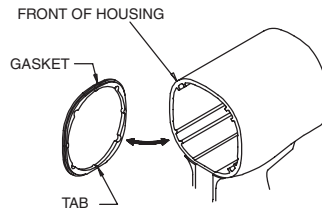

(Dwg. TPA1811)

5. Install the Hammer Case Screws (12) and tighten them to 15 in-lb (1.7 Nm) torque.

Troubleshooting Guide

Troubleshooting Guide		
Trouble	Probable Cause	Solution
Low power	Dry Motor	Daily , inject 3 cc of Ingersoll-Rand No. 50 Oil into the inlet and run the tool to lubricate the motor.
	Inadequate air supply	Install proper air supply and connection. Refer to Installation Diagram in the Product Information Manual Form 04584710
	Dirty Inlet Bushing Screen	Using a clean, suitable, cleaning solution in a well ventilated area, clean the Inlet Bushing Screen.
	Worn or broken Vanes	Replace a complete set of Vanes
	Worn or broken Cylinder and/or scored End Plates	Examine Cylinder. Check outside and ends for wear or damage and inside for scored or wavy bore. Replace Cylinder if any of these conditions exist. Replace End Plates if they are scored.
	Dirty motor parts	Disassemble the Tool and clean in a clean, suitable, cleaning solution in a well ventilated area. Assemble the Tool and inject 3 cc of the recommended oil into Inlet and run Tool to lubricate internal parts.
	Damaged Reverse Valve	Replace Reverse Valve. Refer to Installation of Reverse Valve .
Motor will not run	Incorrect assembly of motor	Disassemble motor and replace worn or broken parts and reassemble. Refer to Assembly of the Motor .
	Insufficient lubricant in impact mechanism	Lubricate impact mechanism through Hammer Case Grease Fitting using the recommended grease.
Tool will not impact	Broken or worn impact mechanism parts	Remove Hammer Case Assembly and examine impact mechanism parts. Replace any worn or broken parts.
	Impact mechanism not assembled correctly	Refer to Assembly of Impact Mechanism .

Related Documentation

For additional information refer to:
 Air Impact Wrench Product Safety Information Manual Form 04580916,
 Air Impact Wrench Product Information Manual Form 04584710,
 Air Impact Wrench Parts List Manual Form 04584009.

Manuals can be downloaded from www.irtools.com.



www.irtools.com

© 2004 Ingersoll-Rand Company