

## Parts for Motor Case

No.	Name of parts	Per set	parts No.
M	Motor Case Assy.	1Set	0447 0011 00 99
M1	Motor Case (A)	1	0447 0011 00 01
M2	Motor Case (B)	1	0447 0011 00 02
M3	Motor Case (C)	1	0446 0011 00 03
M4	Tapping Screw M3x16	7	9540 1018 00 00
M5	Motor Assy.	1Set	0446 0330 00 99
M6	Fan D03X-05TM11(CX)	1	0446 1556 00 00
M7	Cross Recessed Screw M3×16	2	9410 2056 00 00
M8	Power Circuit Board Assy.	1Set	0446 0195 00 99
M9	Head Screw	3	9410 4002 00 00
M10	Harness (A)	1	0446 0208 00 01
M11	Controll Circuit Board Assy.	1Set	0446 1608 07 99
M12	O-Ring (S6)	2	9010 4026 00 00
M13	Harness (B)	1	0446 0208 00 02
M14	Wireless Circuit Board Assy.	1Set	0446 1533 01 99
M15	Lamp Holder	1	0446 0959 01 00
M16	Throttle Knob Assy.	1Set	0446 0153 00 99
M17	Spring 7.5×27	1	8020 1428 00 00
M18	Reverse Lever Assy.	1Set	0446 0007 00 99
M19	Reverse Lever Spring	1	0446 1615 00 00
M20	Tapping Screw M2.6x5	1	9540 1019 00 00
M21	Binding Band (CV-70N)	5	9790 1008 00 00
M22	Rubber Packing	1	0446 0359 00 00
Optional Accessories			
10	Protector (for BPL-1820)	1	0446 0029 00 01
11	Battery Pack BPL-1820	1	0446 1521 00 00
	Battery Charger BC0075G	1	0446 1606 00 00
	Power Cord 1.5M (Domestic)	1	8521 0008 00 00
	Power Cord 1.5M (R. Pin for Europe)	1	8521 0009 00 00
	Power Cord 1.5M <VM0718-VM0719> for China	1	8521 0029 00 00
	Power Cord 1.5M <VM0228A-VM0296> for US	1	8521 0032 00 00
	Power Cord 1.5M <VM0773-VM0776> for India	1	8521 0033 00 00
	Hanger	1	0446 0017 00 00
	Hanger Clip	1	0446 1801 00 00



## Battery System Wrench with built-in angle sensor

MODELS (YES.No.)	TOOL No.
YS-e950 (00)	0447 0000 0000

### Exploded View of Motor Case

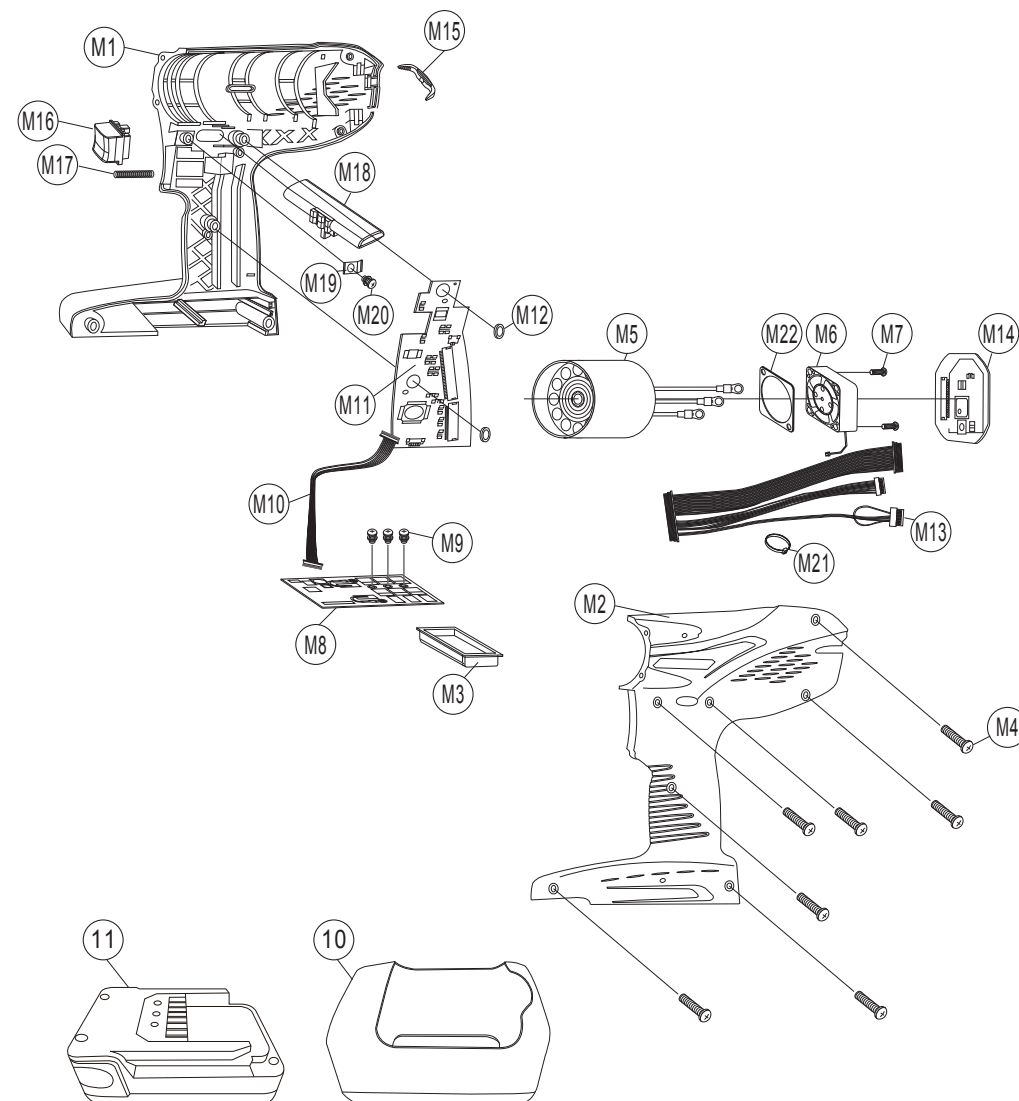

**YOKOTA INDUSTRIAL CO.,LTD.**

### Parts for Liner Case

No.	Name of parts	Per set	parts No.
L	Liner Case Assy.	1Set	0447 0422 00 99
L1	Liner Case	1	0447 0422 00 00
L2	O-Ring 1.78×33.05×36.61	1	9011 2002 00 00
L3	Liner Cap	1	0368 0423 00 00
L4	Liner Upper Plate	1	0181 0424 00 00
L5	O-Ring 1.78×29.87×33.43	1	9011 2003 00 00
L6	Liner Assy.	1Set	0181 0425 00 99
	(a) Liner	1	※ ↑
	(b) Pin FF AA3×4.5	4	8052 3004 00 00
L7	Relief Valve	1	0446 0245 00 00
L8	Pin 1.5×4	1	8051 1314 00 00
L9	Liner Shaft	1	0181 0796 01 00
L10	Blade	2	0181 0719 01 00
L11	Spring 3.4×28	2	8020 1346 00 00
L12	Liner Lower Plate Assy.	1Set	0181 0426 01 99
	(a) Liner Lower Plate	1	※ ↑
	(b) Pin AA3×4.5	1	8052 3004 00 00
L13	Adjust Bolt	1	0181 0522 00 00
L14	O-Ring N2	1	9010 4001 00 00
L15	Back-up Ring N2	1	9090 2001 00 00
L16	Nylon Bushing	1	0181 0431 00 00
L17	Oil Plug	2	0181 0010 00 00
L18	O-Ring N2	2	9010 4001 00 00
L19	O-Ring P12	1	9011 7001 00 00
L20	Back-up Ring 12×16×0.8	1	9090 1010 00 00
1	Washer 12×15.8×4.8	1	8040 1165 00 00
★2	Washer 11.5×16×0.2	1	8041 5046 00 00
★3	Washer 11.5×16×0.3	1	8041 5026 00 00
★4	Washer 11.5×16×0.4	1	8041 5065 00 00
★5	Washer 11.5×16×0.5	1	8041 5022 00 00

The part "※" can not be supplied individually.  
So please order it as a unit of assembly shown by  
arrow mark (↑).

☆marked parts ; one of them is used.

## Battery System Wrench with built-in angle sensor

MODELS (YES.No.)	TOOL No.
YS-e950 (00)	0447 0000 0000

### Exploded View of Liner Case & Hammer Case

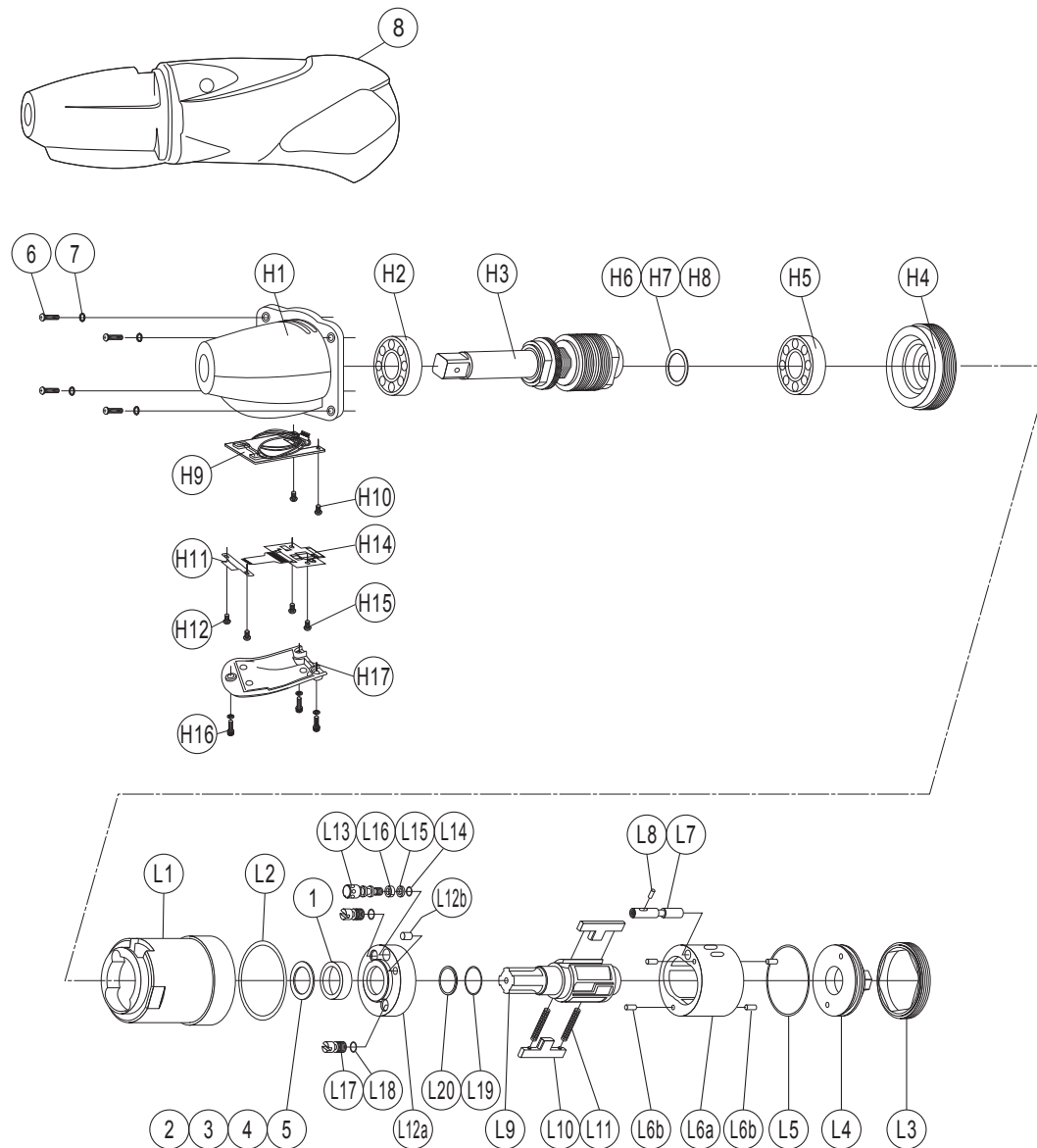

### Parts for Hammer Case

No.	Name of parts	Per set	parts No.
H	Hammer Case Assy.	1Set	0447 0401 00 99
H1	Hammer Case	1	0446 0401 00 00
H2	Ball Bearing 6801ZZ	1	9100 5028 00 00
H3	Main Shaft Assy.	1Set	0446 0614 00 99
H4	Bearing Case	1	0446 0650 00 00
H5	Ball Bearing 6802ZZ	1	9100 5037 00 00
★H6	ST-Packing 20×23.6×0.2	1	8011 1167 00 00
★H7	ST-Packing 20×23.6×0.3	1	8011 1168 00 00
★H8	ST-Packing 20×23.6×0.4	1	8011 1169 00 00
H9	Wire Circuit Board	1	0446 1611 00 00
H10	Screw M3x8	2	9440 2029 00 00
H11	Sensor Base Assy.	1Set	0446 0345 01 99
H12	Wire Circuit Board	2	9440 2029 00 00
★H13	ST-Packing 3.4×6.1×0.1	2	8011 1166 00 00
H14	Torque Circuit Board Assy.	1Set	0446 1607 04 99
H15	Screw M3x6 P=0.5	2	9400 2014 00 00
H16	Cover Plate	1	0446 0014 00 00
H17	Screw M3x10	3	9440 2013 00 00
6	Hexagon Socket Bolt M4×14	4	8070 3008 00 00
7	Spring Washer M4	4	9200 3012 00 00
Optional Accessories			
8	Protector	1	0447 0029 00 00
	TF Pin	1	8051 6001 00 00

The part "※" can not be supplied individually.  
So please order it as a unit of assembly shown by  
arrow mark (↑).

☆marked parts ; one of them is used.